

13

Articulators & Impression Trays

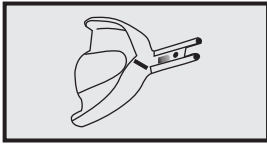



Articulators



DC37-001-00

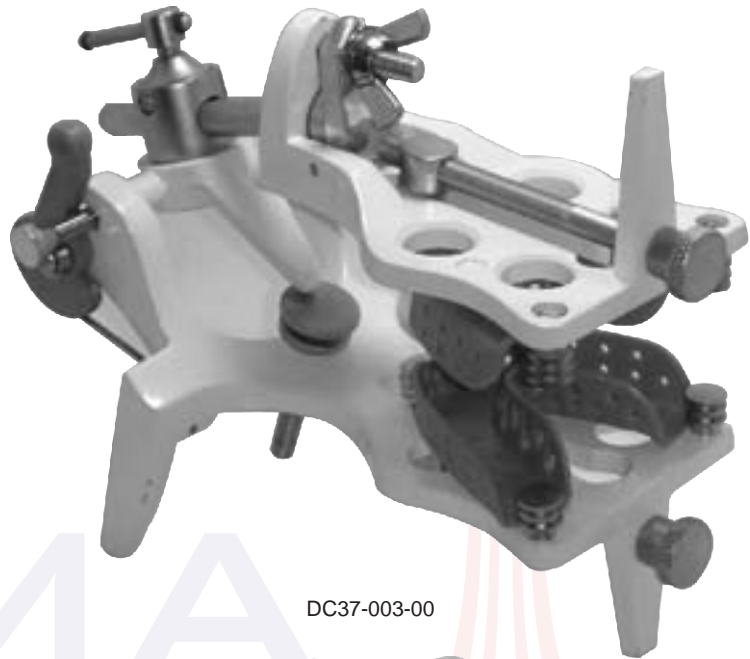

DC37-003-00



DC37-005-00

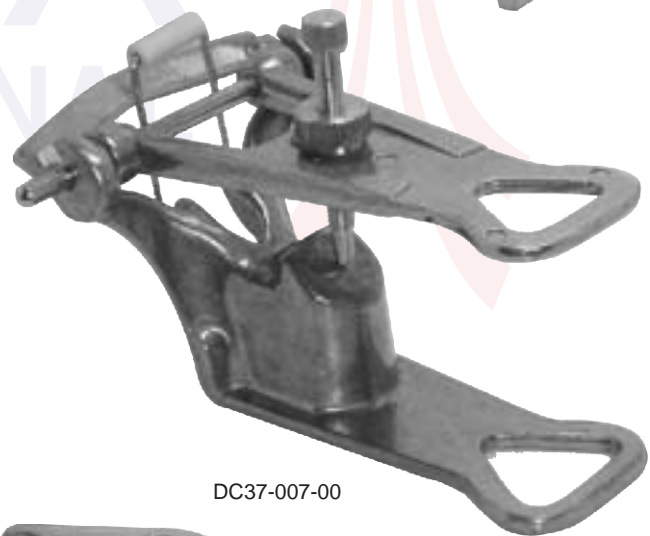

DC37-007-00



DC37-009-00

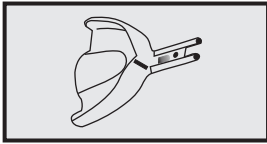

Articulators



DC37-011-00

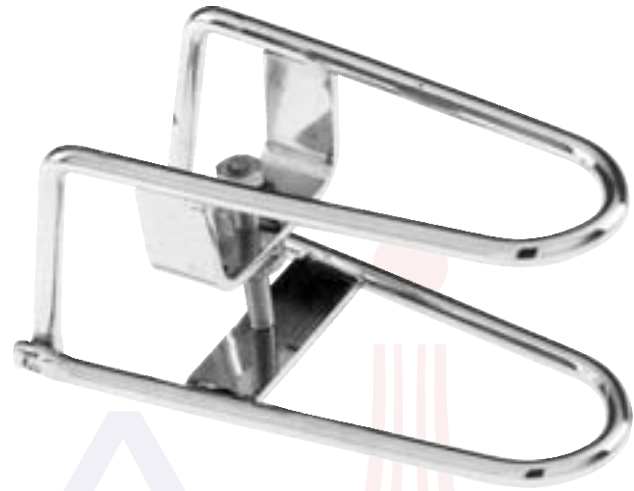

DC37-013-00



DC37-015-00



DC37-017-00

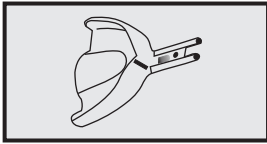

Impression Trays

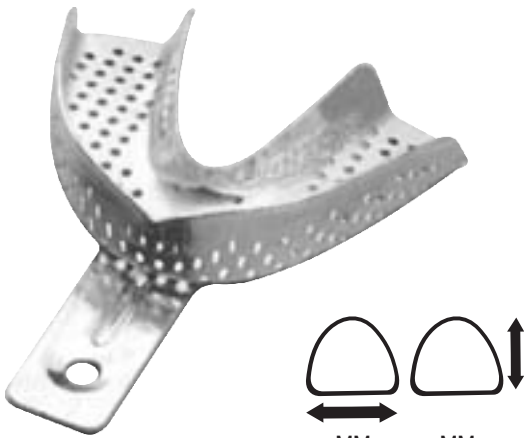

		MM	MM
DC37-019-U1	XXS	63	48
DC37-019-U2	XS	66	51
DC37-019-U3	S	68	54
DC37-019-U4	M	71	58
DC37-019-U5	L	74	62
DC37-019-U6	XL	76	63

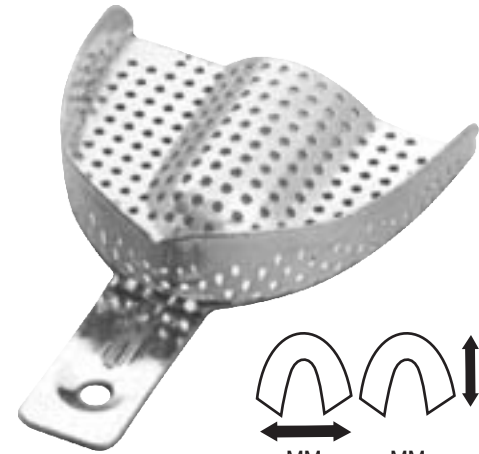

		MM	MM
DC37-021-L1	XXS	56	48
DC37-021-L2	XS	59	50
DC37-021-L3	S	72	52
DC37-021-L4	M	76	57
DC37-021-L5	L	77	56
DC37-021-L6	XL	78	59

Set of Twelve DC37-022-12

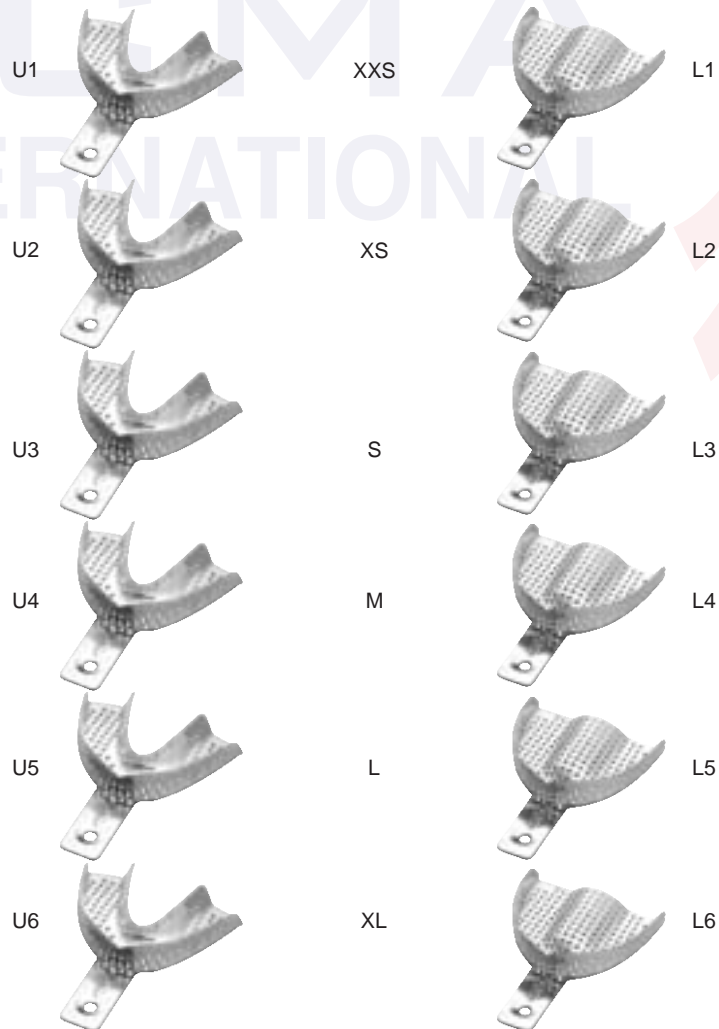

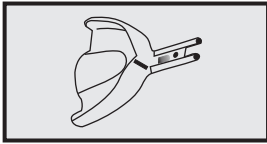

Impression Trays

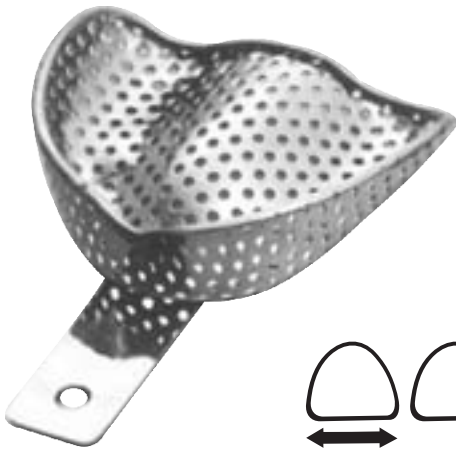

		MM	MM
DC37-023-U1	L	81	67
DC37-023-U4	M	71	64
DC37-023-U7	S	70	57

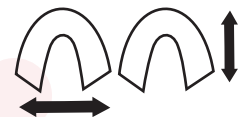
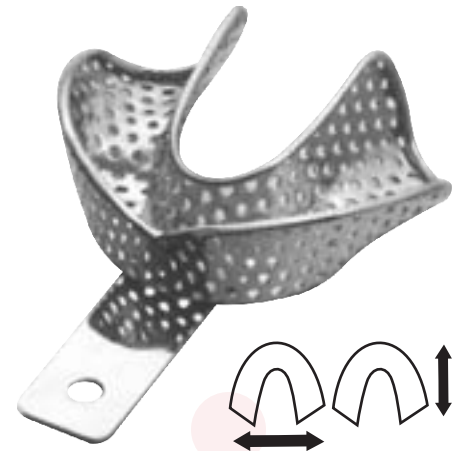

		MM	MM
DC37-025-L20	L	81	60
DC37-025-L21	M	79	57
DC37-025-L22	S	76	54

ACMA INTERNATIONAL

Set of Six DC37-027-06

U1



L

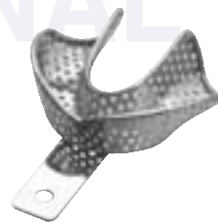

L20

U4



M



L21

U7



S



L22

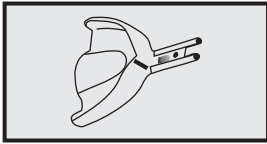

Impression Trays

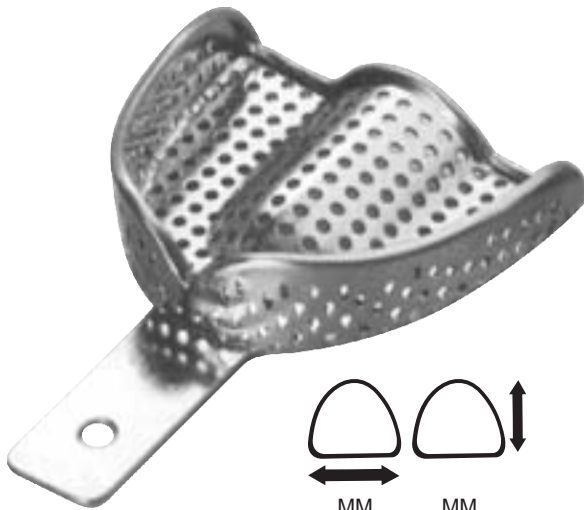

		MM	MM
DC37-029-U1	XXS	63	47
DC37-029-U2	XS	64	51
DC37-029-U3	S	66	53
DC37-029-U4	M	69	57
DC37-029-U5	L	71	60
DC37-029-U6	XL	73	62

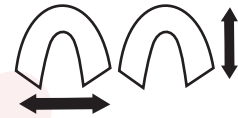

		MM	MM
DC37-031-L1	XXS	55	47
DC37-031-L2	XS	60	49
DC37-031-L3	S	72	54
DC37-031-L4	M	74	57
DC37-031-L5	L	76	59
DC37-031-L6	XL	78	61

Set of Twelve DC37-033-12

ACMA INTERNATIONAL

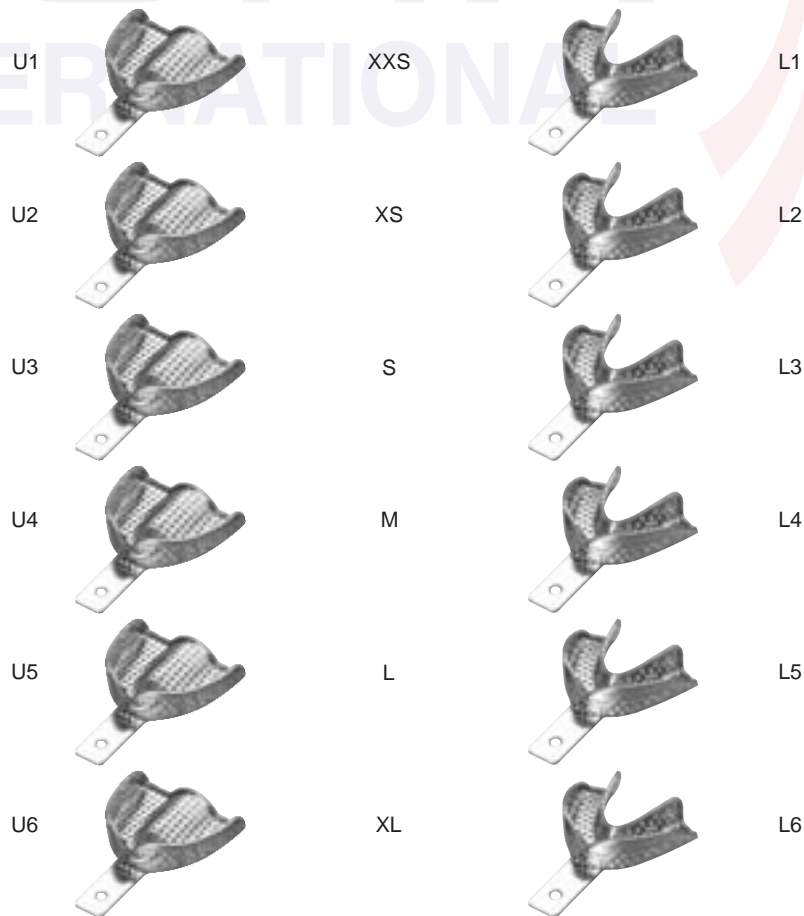

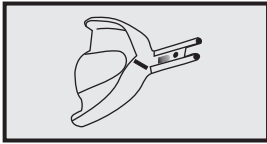

Impression Trays

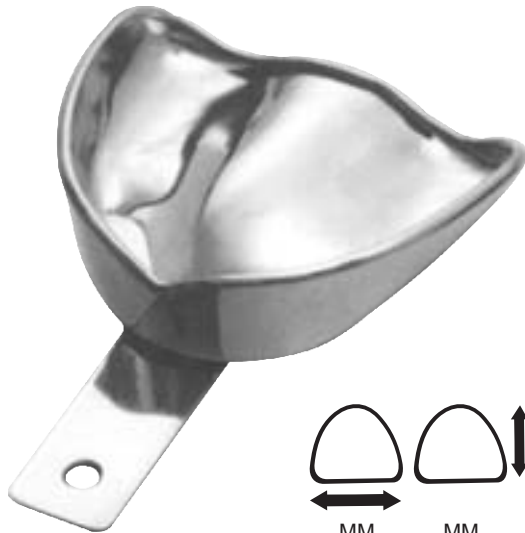

		MM	MM
DC37-035-U1	L	81	67
DC37-035-U4	M	71	64
DC37-035-U7	S	70	57



		MM	MM
DC37-037-L20	L	81	60
DC37-037-L21	M	79	57
DC37-037-L22	S	76	54

ACMA INTERNATIONAL

Set of Six DC37-039-06

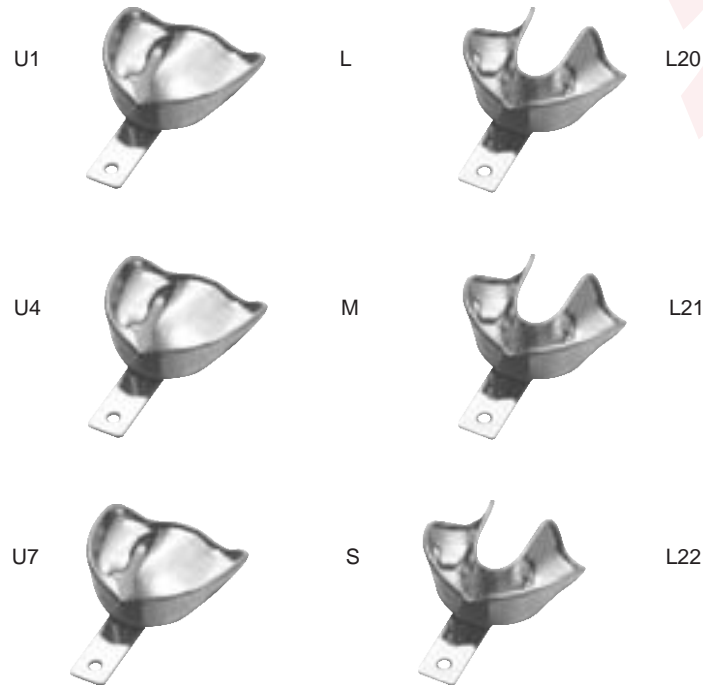

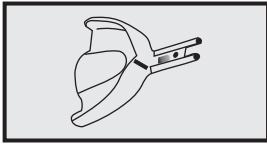

Impression Trays

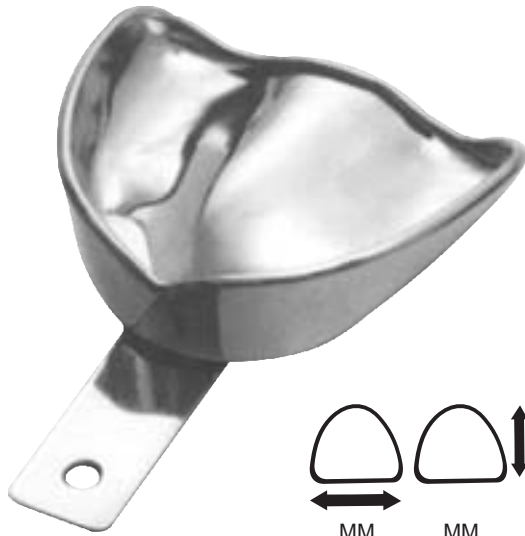

		MM	MM
DC37-041-U1	L	81	67
DC37-041-U4	M	71	64
DC37-041-U7	S	70	57



		MM	MM
DC37-043-L20	L	81	60
DC37-043-L21	M	79	57
DC37-043-L22	S	76	54

ACMA INTERNATIONAL

Set of Six DC37-045-06

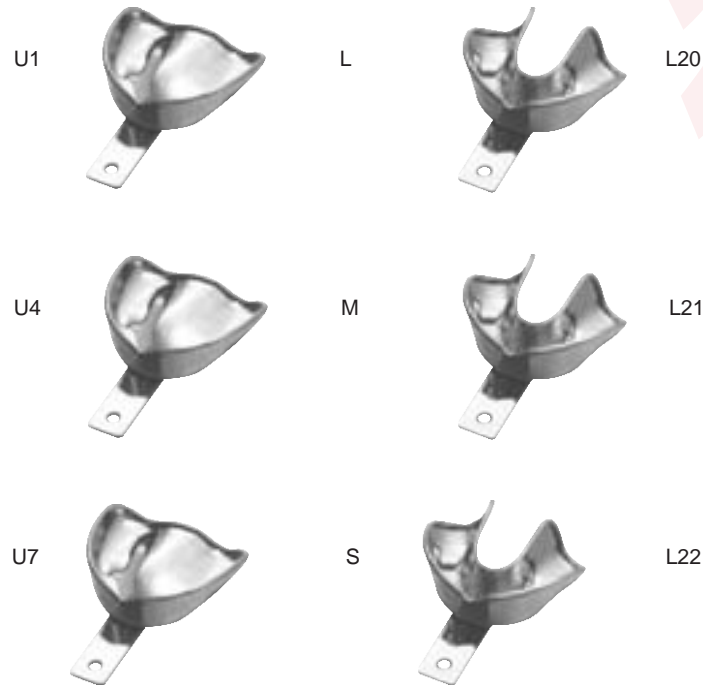

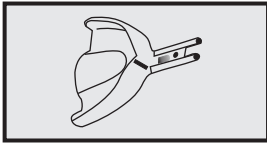

Impression Trays



		MM	MM
DC37-047-U1	XL	73	62
DC37-047-U2	L	71	60
DC37-047-U3	M	69	57
DC37-047-U4	S	66	53
DC37-047-U5	XS	64	51
DC37-047-U6	XXS	61	47

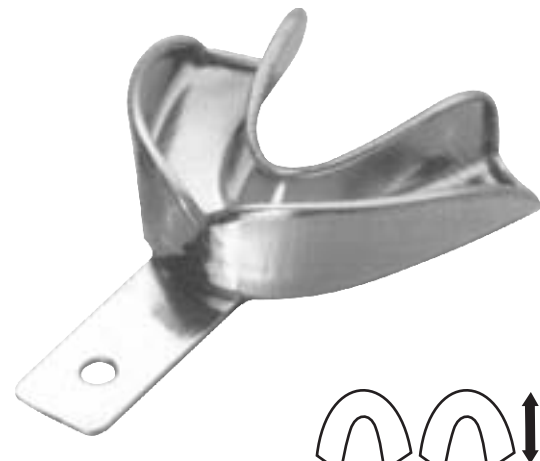

		MM	MM
DC37-049-L1	XL	78	61
DC37-049-L2	L	76	59
DC37-049-L3	M	75	57
DC37-049-L4	S	72	54
DC37-049-L5	XS	60	49
DC37-049-L6	XXS	55	47

Set of Ten DC37-051-12

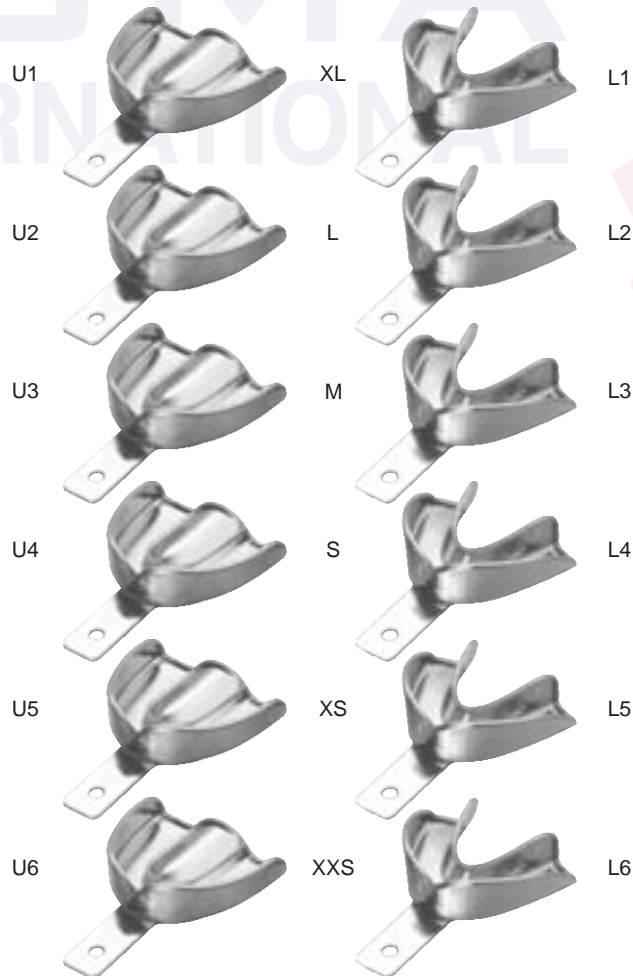

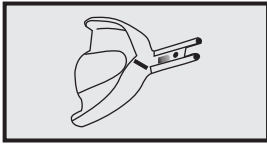

Impression Trays

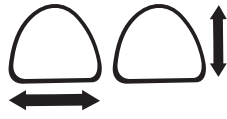

		MM	MM
DC37-053-U1	XL	81	63
DC37-053-U2	L	74	60
DC37-053-U3	M	71	55
DC37-053-U4	NM	67	53
DC37-053-U5	S	65	51

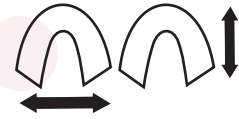

		MM	MM
DC37-055-L1	XL	80	63
DC37-055-L2	L	78	59
DC37-055-L3	M	76	57
DC37-055-L4	NM	72	57
DC37-055-L5	S	69	50

Set of Ten DC37-057-10

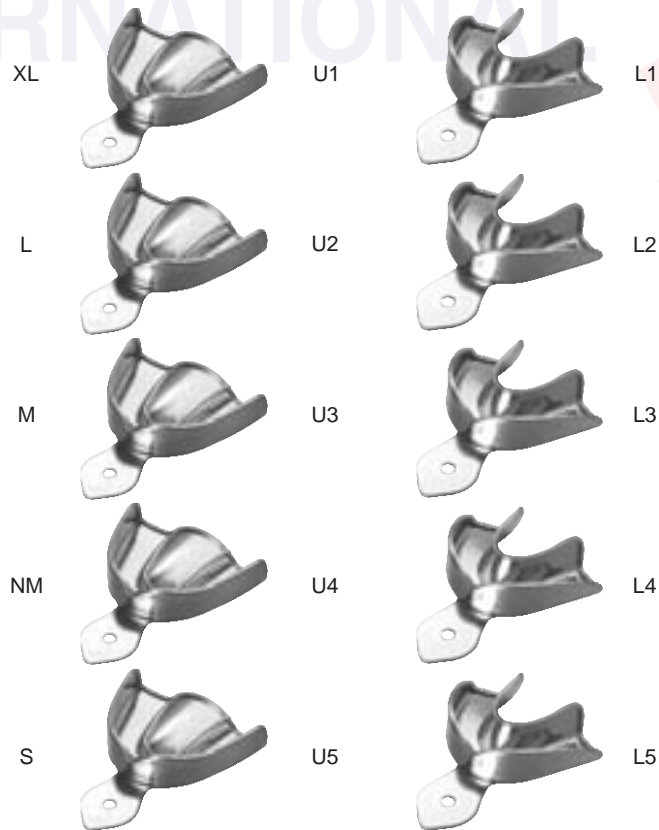

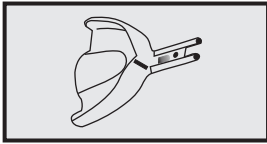

Impression Trays



		MM	MM
DC37-059-U1	XL	68	62
DC37-059-U2	L	75	60
DC37-059-U3	M	73	53
DC37-059-U4	NM	69	54
DC37-059-U5	S	68	52



		MM	MM
DC37-061-L1	XL	82	63
DC37-061-L2	L	81	61
DC37-061-L3	M	78	57
DC37-061-L4	NM	74	60
DC37-061-L5	S	71	53

Set of Ten DC37-063-10

XL

U1

L1

L

U2

L2

M

U3

L3

NM

U4

L4

S

U5

L5

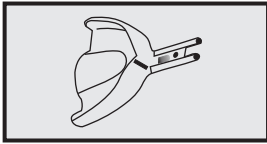

Impression Trays for partial impressions



Form C 1/2 R

Form C 1/2 R

fig.	perforated	unperforated
1	DC37-065-01	DC37-067-11
2	DC37-065-02	DC37-067-12
3	DC37-065-03	DC37-067-13
4	DC37-065-04	DC37-067-14



Form C 1/2 L

Form C 1/2 L

1	DC37-069-01	DC37-071-11
2	DC37-069-02	DC37-071-12
3	DC37-069-03	DC37-071-13
4	DC37-069-04	DC37-071-14



Universal
DC37-073-01

with swivel handle and fixing screw



Universal
DC37-075-11



DC37-077-01

with swivel handle



DC37-079-11



Stolley
DC37-081-01



Stolley
DC37-083-11

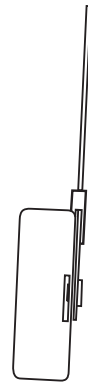

with swivel handle and slide



Melotte
DC37-085-11

for crown work